

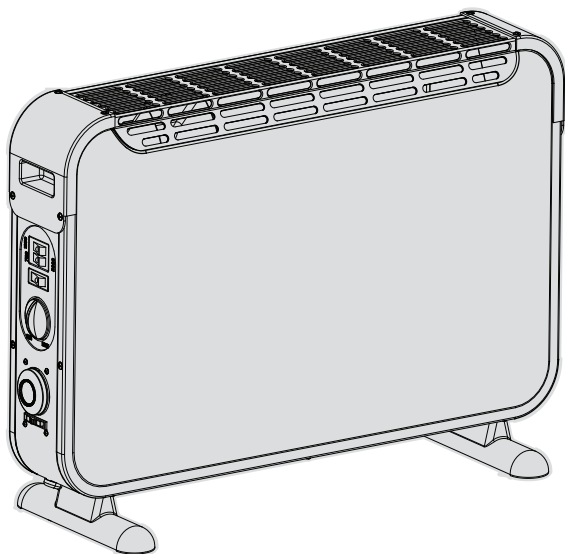

DL15 TURBO & TIMER



- FR Notice de Montage - Utilisation - Entretien
- ES Instrucciones de Montaje, Utilización y Mantenimiento
- PT Instruções de Montagem, Utilização e Manutenção
- IT Istruzioni per il Montaggio, l'Uso e la Manutenzione
- EL Εγχειρίδιο συναρμολόγησης, χρήσης και συντήρησης
- PL Instrukcja Montażu, Użytkowania i Konserwacji
- RO Manual asamblare, utilizare și întreținere
- EN Assembly - Use - Maintenance Manual

EAN CODE : 3276005422506

Traduction de la version originale du mode d'emploi - Convecteur / Traducción de las Instrucciones originales - Convector / Tradução das Instruções Originais - Convétor / Traduzione delle istruzioni originali - Termosconvettore / Μετάφραση των πρωτότυπων οδηγιών - Κομβεκτέρ / tłumaczenie instrukcji oryginalnej - Konwektor / Перевод оригинальной инструкции - Конвекционный Нагреватель / Переклад оригінальної інструкції - Конвектор / Traducerea instructiunilor originale - Convector / Original Instructions - Convector



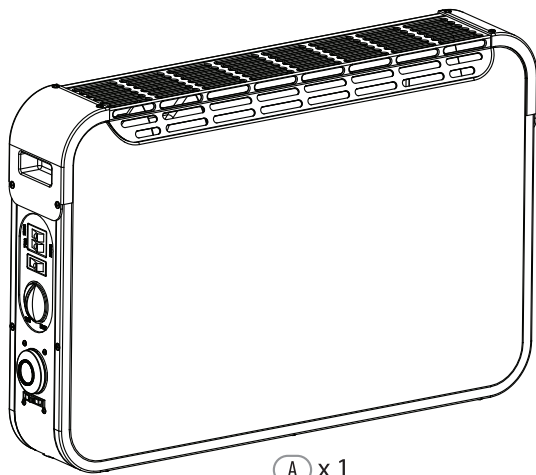
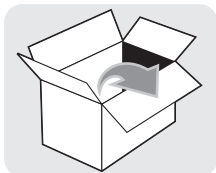

(A) x 1

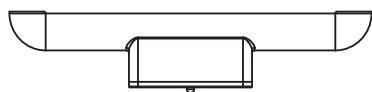

(B) x 2



(C) x 4

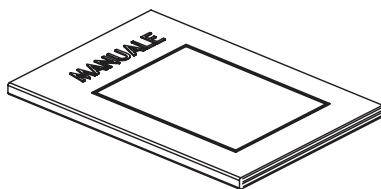

(D) x 1

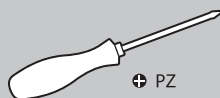
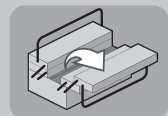



Attention danger / Atención: Peligro / Atencão perigo / Attenzione pericolo / Προσοχή κίνδυνος / Uwaga niebezpieczeństwo / Внимание! Опасно! / Увага! Небезпечно! / Atenție, pericol / Caution danger



Observez / Atención / Aviso / Osservare / Προσέξτε / Przestrzegać / Соблюдайте правила техники безопасности / Дотримуйтеся правил техніки безпеки / Respectați / Observe



Raccordé / Conectado / Ligado / Connesso / Με σύνδεση / Podłączone / Подключено / Під'єднано / Conectat / Connected



Hors tension / Apagado / Desligado da alimentação / Fuori tensione / Εκτός τάσης / Odłączenie zasilania / Не под напряжением / Не під напругою / Scoatere de sub tensiune / Power off



Mise sous tension / Puesta en tensión / Ligação da alimentação / Messo sotto tensione / Σύνδεση με το ηλεκτρικό δίκτυο / Włączenie zasilania / Включение под напряжение / Під'єднання під напругу / Punere sub tensiune / Power up



Nettoyage / Limpieza / Limpeza / Pulizia / Καθαρισμός / Czyszczenie / Чистка / Очищення / Curățare / Cleaning



Correct / Correcto / Correcto / Corretto / Σωστό / Dobrze / Правильный / Правильно / Corect / Correct



Incorrect / Incorrecto / Incorrecto / Errato / Λάθος / Źle / Неправильный / Неправильно / Incorect / Incorrect



Mentions légales & consignes de sécurité / Instrucciones legales y de seguridad / Avisos legais e instruções de segurança / Istruzioni legali e di sicurezza / νομικό σημείωμα και οδηγίες ασφαλείας / uwagi prawne i instrukcja bezpieczeństwa / руководство по технике Безопасности и правовым нормам / керівництво з техніки Безпеки і правовим нормам / manual privind siguranța și aspectele juridice / Legal & safety instructions

**Notes / Observaciones / Notas / Note /
Σημειώσεις / Notatki / Примечания /
Примітки / Note / Notes**

A

FR Montage

ES Montaje

PT Montagem

IT Montaggio

EL Συναρμολόγηση

PL Montaż

RU Сборка

UA Збірка

RO Montaj

EN Assembly

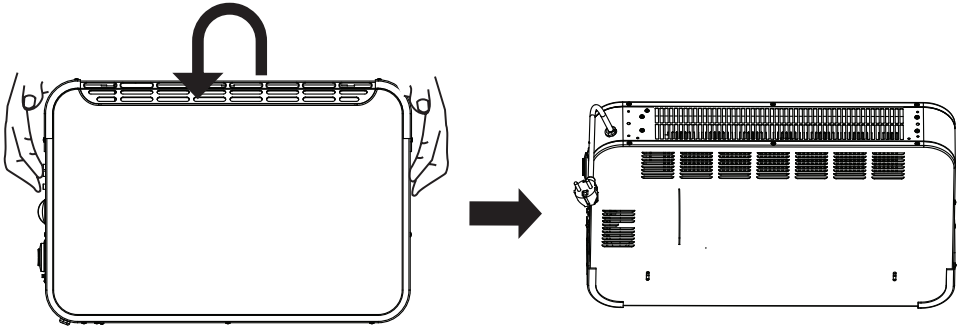
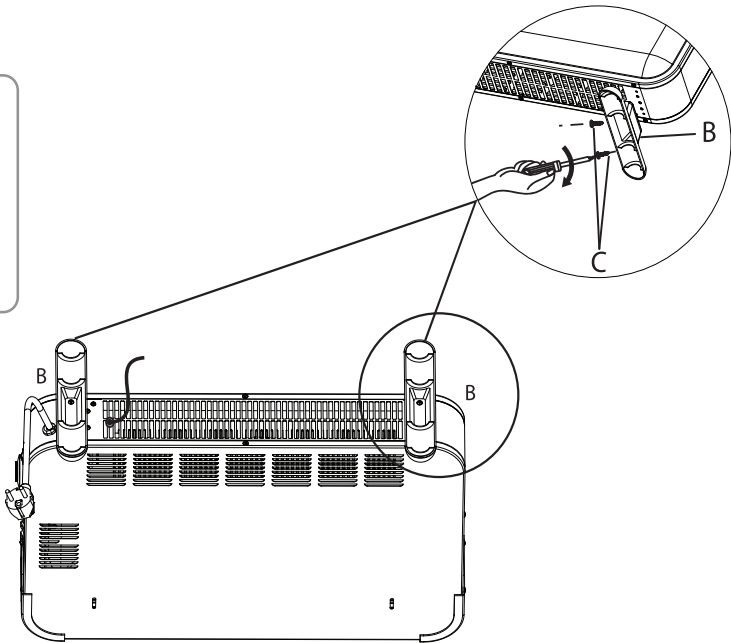
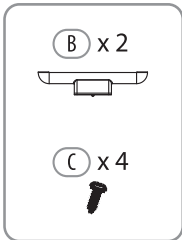
1**2**

FR Montage

ES Montaje

PT Montagem

IT Montaggio

EL Συναρμολόγηση

PL Montaż

RU Сборка

UA Збірка

RO Montaj

EN Assembly

A

3

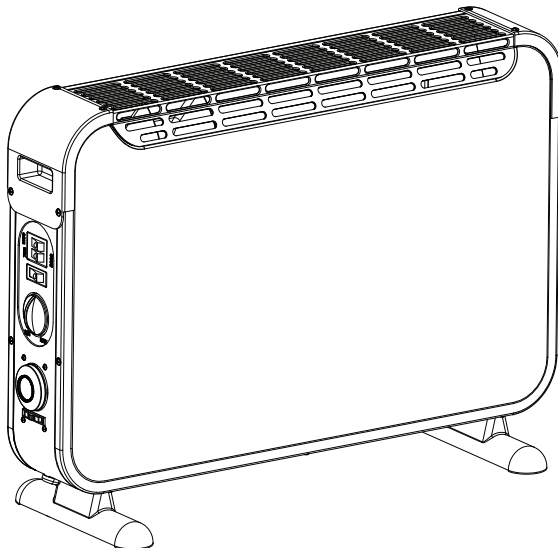
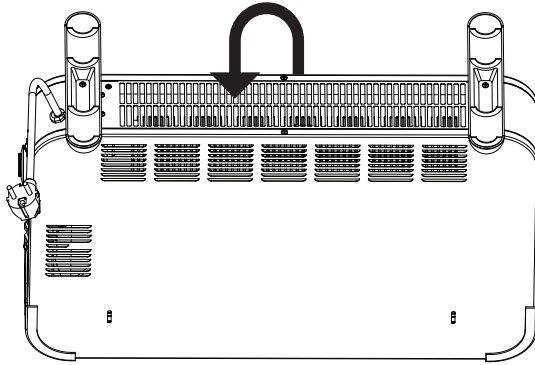

B

FR Utilisation

ES Utilización

PT Utilização

IT Uso

EL Χρήση

PL Użytkowanie

RU Использование

UA Використання

RO Utilizare

EN Use



1

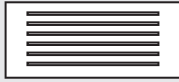

AC220-240V~50-60Hz

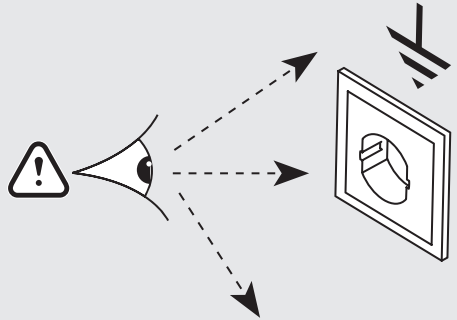
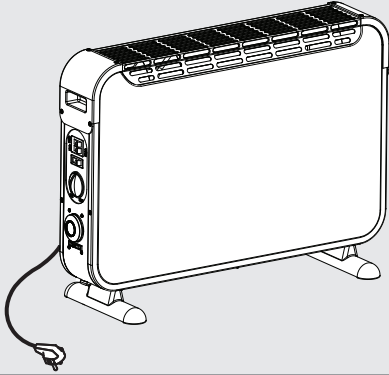

AC220-240V~50-60Hz

2

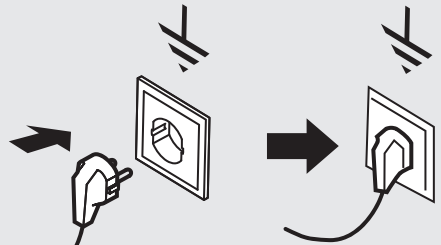
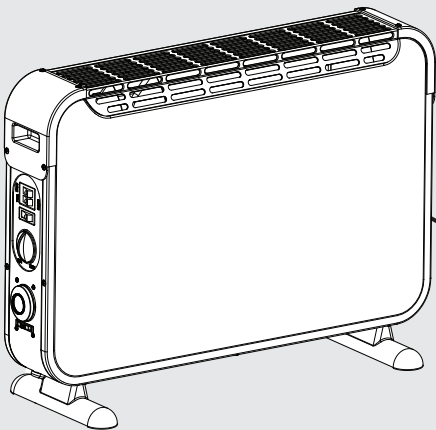



3

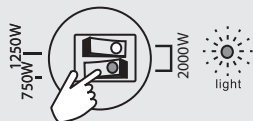
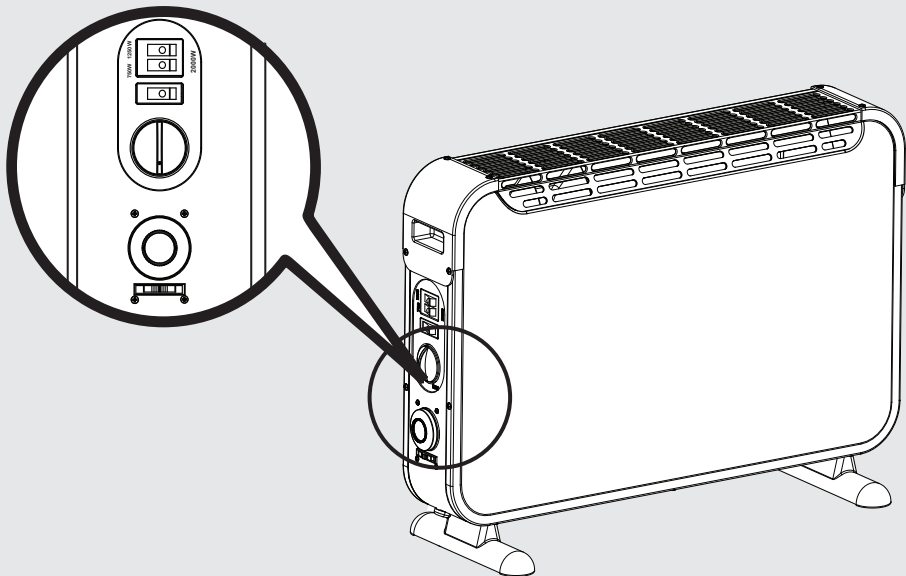

750 W



1250 W



2000 W



B

FR Utilisation

ES Utilización

PT Utilização

IT Uso

EL Χρήση

PL Użytkowanie

RU Использование

UA Використання

RO Utilizare

EN Use



4

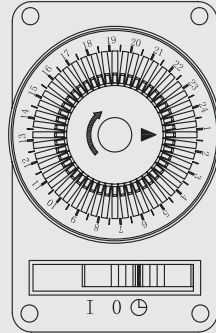
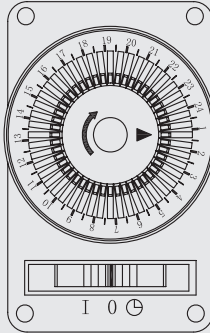
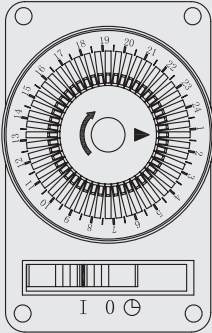

24 H

5

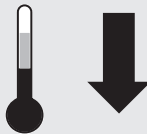
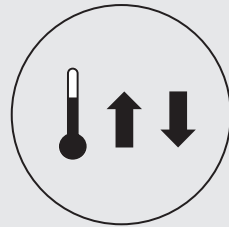
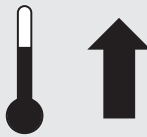
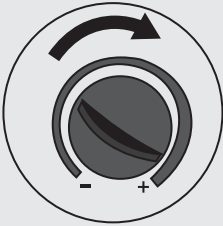

- FR Utilisation ES Utilización PT Utilização IT Uso
EL Χρήση PL Użytkowanie RU Использование UA Використання
RO Utilizare EN Use

B



6

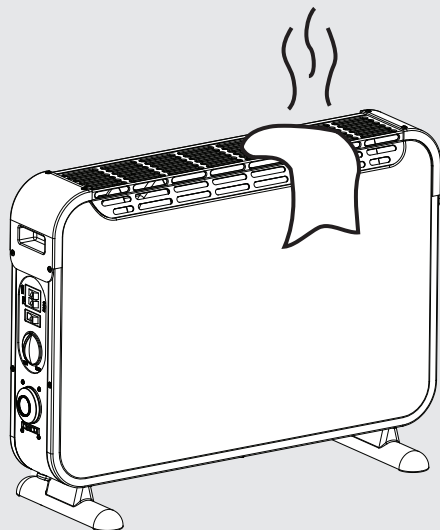

FR Entretien

ES Mantenimiento

PT Serviço

IT Manutenzione

EL Συντήρηση

PL Konserwacja

RU Уход

UA Догляд

RO Întreținere

EN Maintenance

C



1

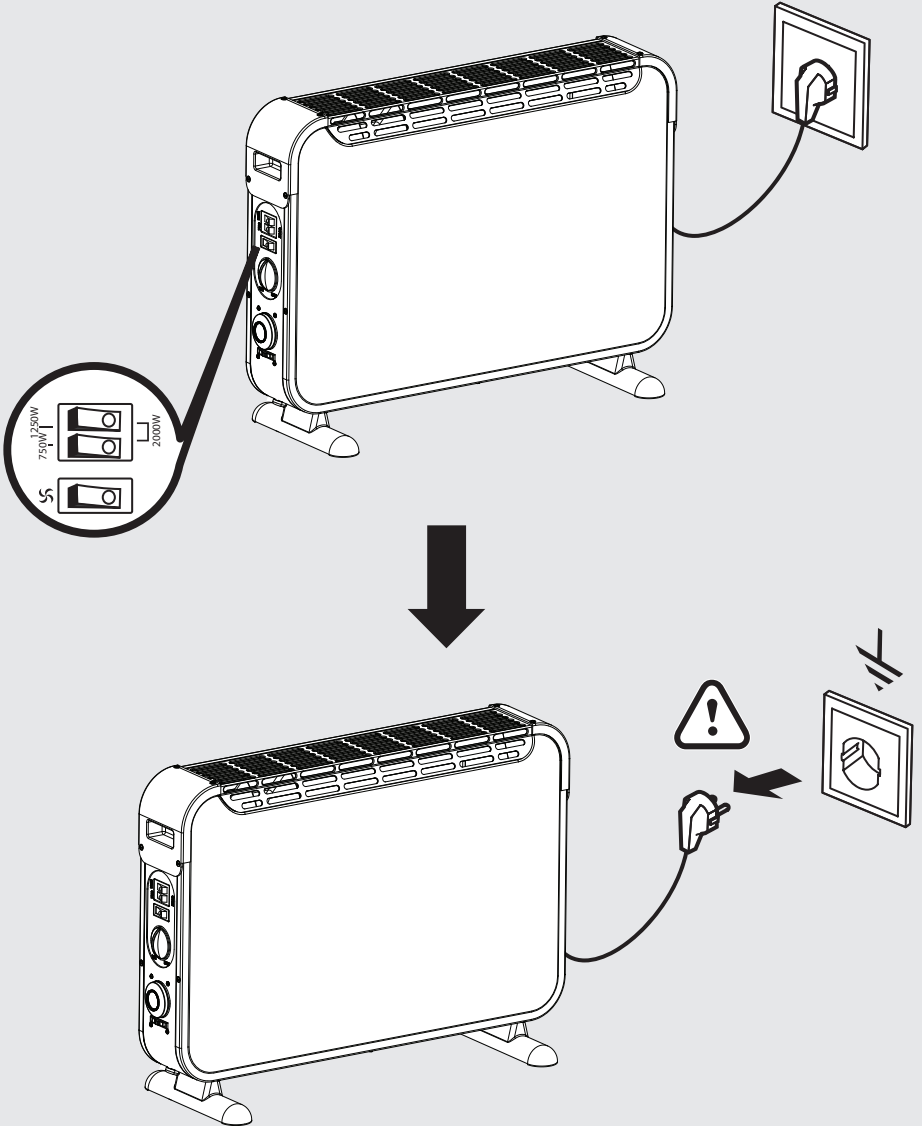

C

FR Entretien

ES Mantenimiento

PT Serviço

IT Manutenzione

EL Συντήρηση

PL Konserwacja

RU Уход

UA Догляд

RO Întreținere

EN Maintenance



2



5 MinS

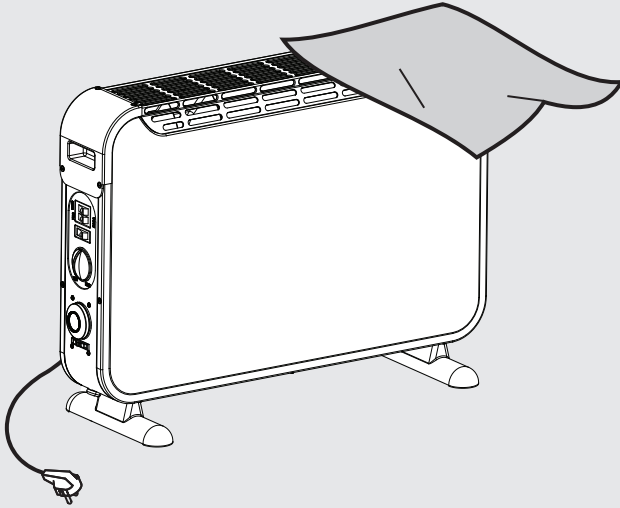

3

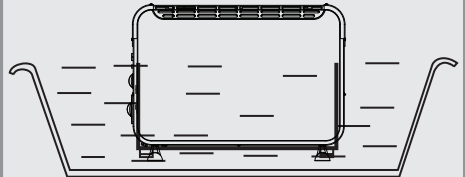
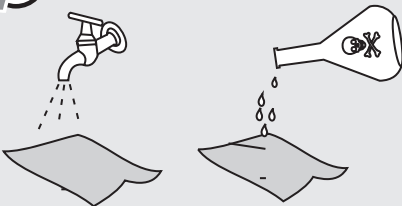
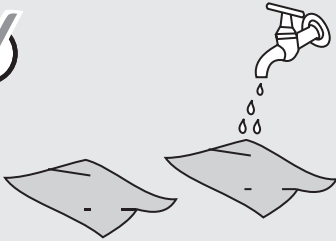

FR Entretien

ES Mantenimiento

PT Serviço

IT Manutenzione

EL Συντήρηση

PL Konserwacja

RU Уход

UA Догляд

RO Întreținere

EN Maintenance

C

4

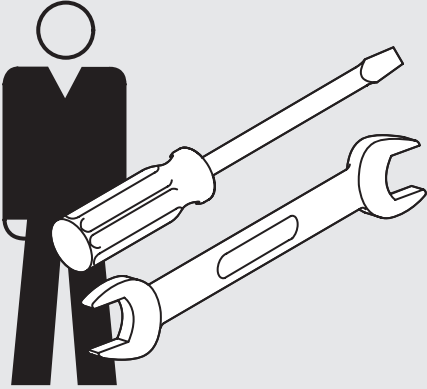

D

FR Hivernage

EL Αποθήκευση το χειμώνα

RO Păstrare pe perioada iernii

ES Durante el invierno

PL Przechowywanie

EN Winter storage

PT Preparação para o inverno

RU Зимний период

IT Rimessaggio

UA Зимовий період

1

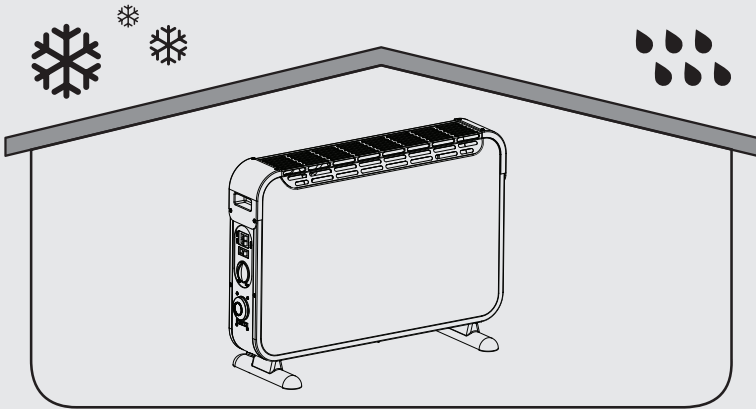

* Garantie 2 ans / 2 años de garantía / Garantia de 2 anos / Garanzia 2 Anni / Εγγύηση 2 ετών / Gwarancja 2-letnia / Гарантия 2 года / Гарантія 2 років / Garanție 2 ani / 2-years guarantee



FR ADEO Services - 135 Rue Sadi Carnot - CS 00001
59790 RONCHIN - France

RU ООО ЛЕРУА МЕРЛЕН ВОСТОК, 141031, Московская область,
Мытищинский район, г. Мытищи, Осташковское шоссе,
д.1, РОССИЯ

UA ТОВ «Леруа Мерлен Україна»,
вул. Полярна 17а, м. Київ 04201, Україна



Made in P.R. C. 2018